

Three-Handle Valve (Two Outlets)
7920-Z0-81CP

INTRODUCTION:

JUSTIME made some transformation in oval to increase a sense of modernity, fitting the fashion of this generation, and adding elegant style into 6920 Series.



DESCRIPTION:

- 1.Casting valve body material meets ISO CuZn40Pb standard.
- 2.Forging handle material meets JIS 3771 standard.
- 3.The body of valve should be buried in the wall beforehand with 1"(2.5cm) adjusting tolerance in depth.
- 4.Chrome plated finish has met the ASTM-SC2 standard.
- 5.The connecting thread of main body is G 1/2.

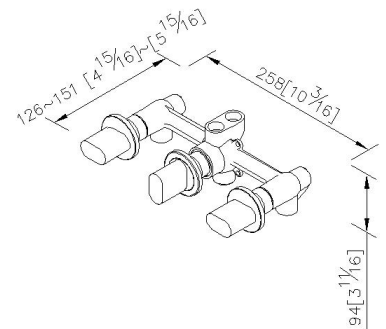

unit:mm[inch]

Certification:

Fixing Kits:

- 1.

AWARD: