

INSTALLATION INSTRUCTIONS

Rain Shower system

淋浴柱安裝說明

Applicable Product Number:

適用產品型號:

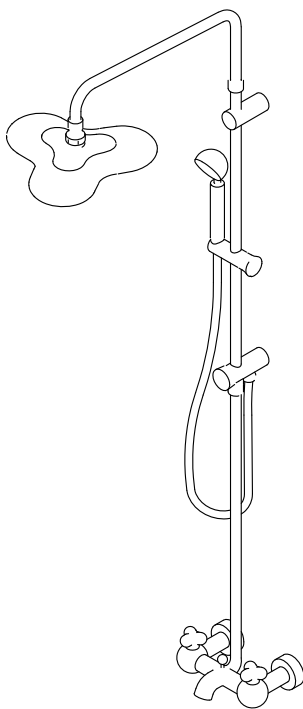

6903-BD-80CP

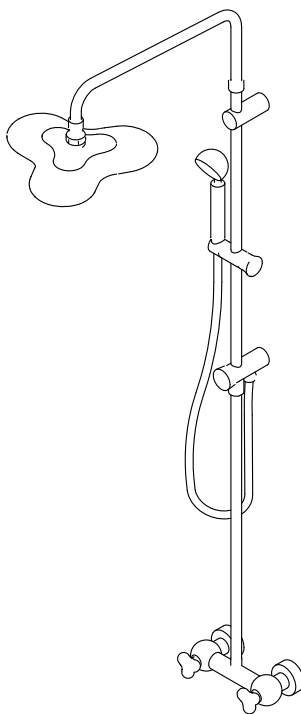

6903-BF-80CP

CARE & CLEANING

清潔與保養

CAUTION : This product might be damaged by improper installation, acid cleaning solution, misuse, improper care and cleaning.

1. Always follow the INSTALLATION INSTRUCTIONS provided and use extreme care while installing.
2. Do not use acid cleaning solution or abrasive cleaner (Ex: Hydrochloric acid or toothpaste); test your cleaning solution on an inconspicuous area before applying to the entire surface.
3. Wipe surfaces clean and rinse completely with water immediately after applying cleaner. Do not soak with cleaners. Rinse and dry any overspray that lands on nearby surfaces.
4. Use a dampened sponge or cloth to clean surface. (Do not use abrasive material such as brush or scouring pad.)

注意：此產品有可能因為不當安裝，誤用酸性清潔劑或清潔方式不正確而造成產品受損。

1. 產品安裝時必須依照產品所附的安裝說明和操作方式安裝。
2. 不可使用含有酸性或具研磨效果的清潔劑清洗（例如：鹽酸、牙膏），請先在產品較不顯眼的地方測試您的清潔方法，然後再應用到整個表面。
3. 產品塗佈清潔劑後，應立即擦拭除污，用清水沖洗，並擦乾產品和檯面。切勿讓清潔劑在產品表面浸濕潤漬過久。
4. 請使用濕海綿或乾淨棉布擦拭產品表面。（不可使用會刮傷或具研磨材質的刷子及鋼刷）。

FIXING CONTENTS

組配件內容

A. Mixer Body X 1

龍頭本體

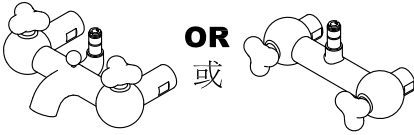

B. Flange X 2

法蘭蓋

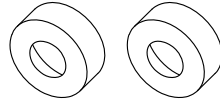

C. Adaptor X 2

轉換接頭

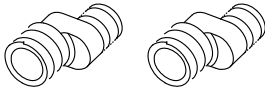

D. Filter Gasket X 2

墊片



E. Sliding-Tube X 1 (With Diverter)

升降桿+切換器

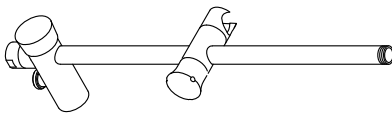

F. Connecting Tube X 1 (69.5cm)

連接管



G. Shower-Tube (Bend) X 1

淋浴彎管



H. Pillar X 1

升降桿支架

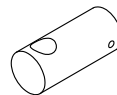

FIXING CONTENTS

組配件內容

I. Hexagon Key X 1

六角扳手



J. Wall Screw X 2

螺絲

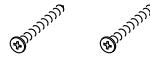

K. Plastic Anchors X 2

塑膠塞

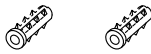

L. Wall Bracket X 2

固定座

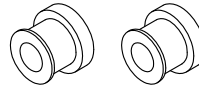

M. Rain-Shower X 1

花灑

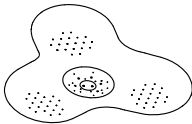

N. Hand Shower X 1

手持花灑

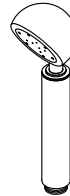

O. Shower Hose X 1

蛇管



P. Hand Shower Tool X 1

手持花灑工具



INSTALLATION NOTE

安裝注意事項

⚠ CAUTION : Please read the following point carefully before Installation.

1. The available distance between two centers of wall water-outlet can be 122mm ~ 178mm as Fig.1 shown.
2. The faucet should be used at the water pressure from 1 to 6 kg/cm².

⚠ CAUTION : Risk of product damage.

When finished installation, turn the valve on and run water for 1 minute to remove any debris before using.

⚠ 注意：安裝前，請詳閱下列注意事項。

1. 確認牆壁上的出水口中心距為122~178mm如圖所示。
2. 適用水壓1~6(kg/cm²)。

⚠ 注意：為增加產品使用壽命，請依說明清潔供水管路。

1. 完成安裝後，需在使用前先把供水開關全開排水持續一分鐘，去除雜質，以保持管路清潔。

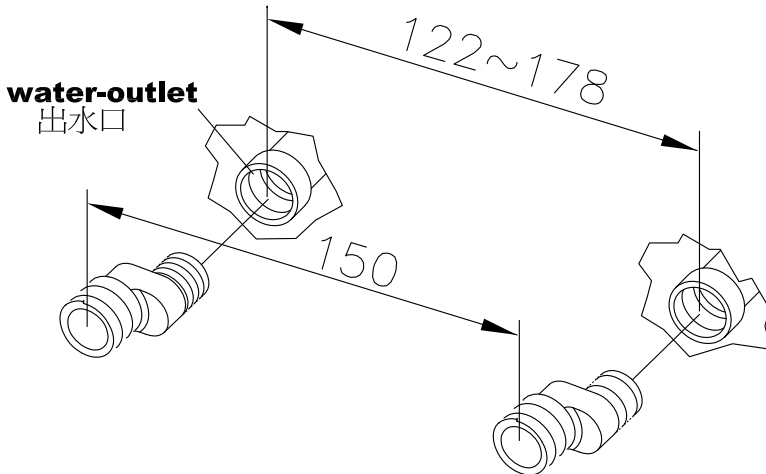

INSTALLATION INSTRUCTIONS

安裝說明

1

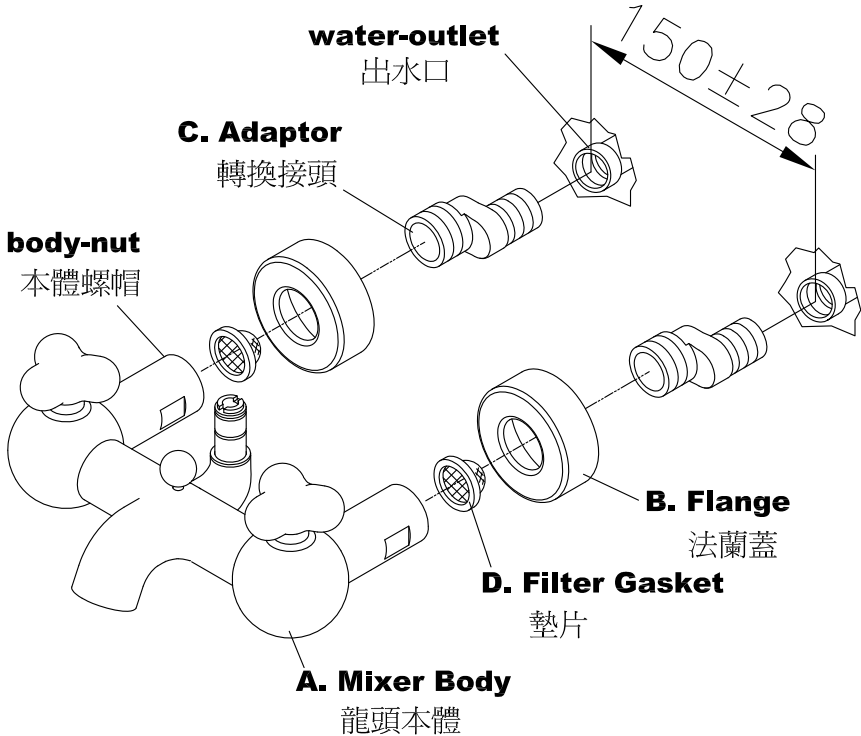

Install the Mixer Body

* Apply pipe compound or thread sealant tape to the thread of **Adaptor** 1/2" end, and screw it into wall water-outlet, meanwhile, adjust the distance between two **Adaptor** 3/4" ends to 150mm for **Mixer Body** connection. Cover **Flange** onto both 3/4" end of **Adaptor**. Insert **Gaskets** into each body-nut, then screw the body-nut onto **Adaptor** 3/4" end and tighten fixed.

將轉換接頭1/2"牙塗上管牙膠或包覆止洩帶，再鎖入牆壁出水口，調整轉換接頭並且確定3/4"那邊的中心距為150mm以便安裝龍頭本體。將二個法蘭蓋各別裝上轉換接頭的3/4"那邊。將二個墊片各別裝入本體螺帽，然後將本體螺帽鎖上轉換接頭3/4"那端並且鎖緊。

2

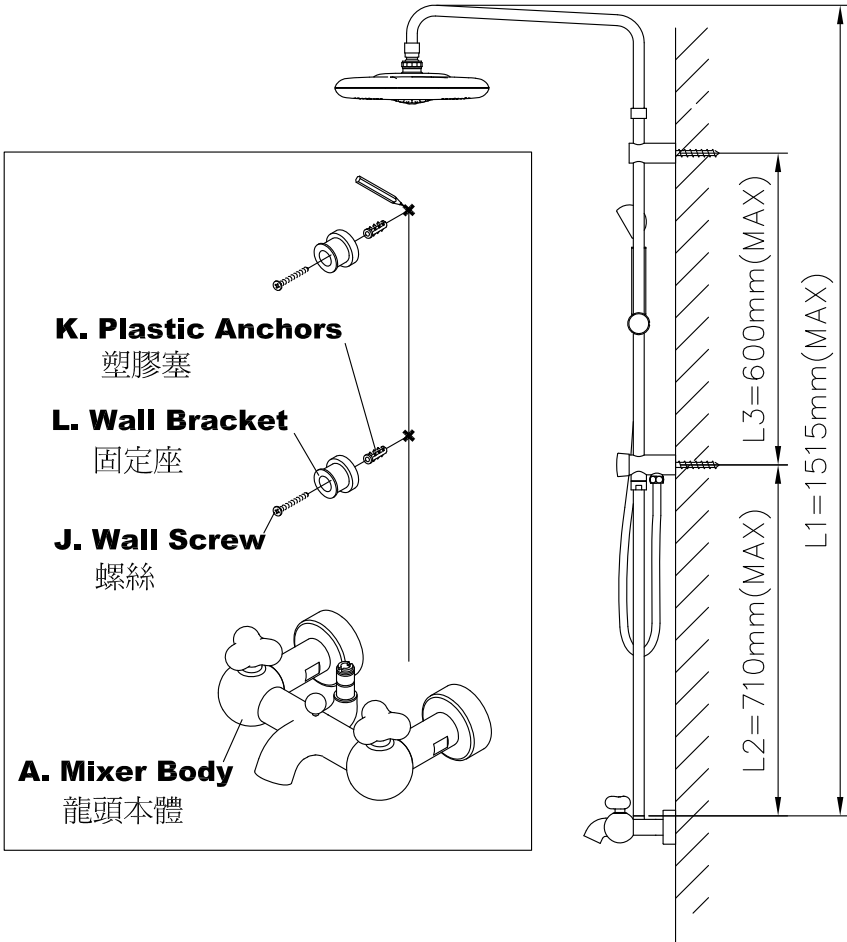

Install the Brackets

* Mark a vertical line on wall right at the middle position between two **Flanges** (Correspondent with the center line of **Mixer-Body**), and meantime mark the drill holes center position as shown. Drill and insert **Plastic Anchors** flush with the wall, then fix the **Wall Brackets** on wall for fixture.

從兩個法蘭蓋的正中間位置畫一條垂直線在牆上（與龍頭本體中心一致），並同時畫上鑽洞用的記號，其位置尺寸如圖所示。鑽孔再裝入塑膠塞並且須與牆壁齊平，裝上牆壁固定座以供安裝使用。

3

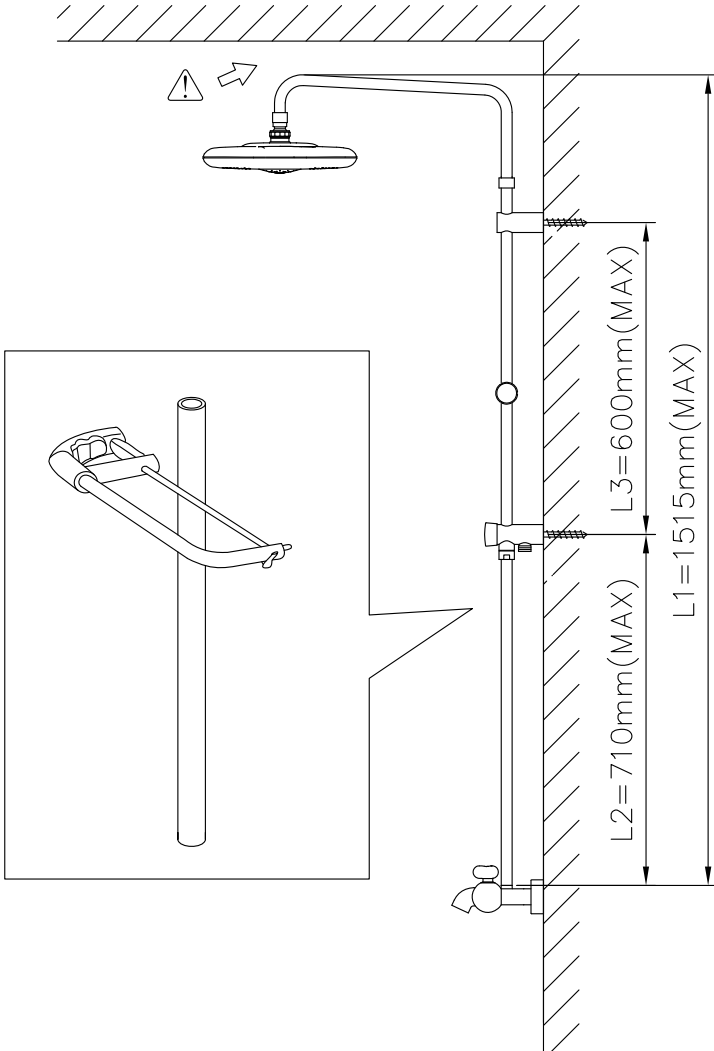

* **WARNING:** Reduce the length of L2 if necessary to ensure whole "Rain-Shower" can be installed beneath the ceiling.

警告：為確保"花灑"可被安裝在天花板之下，有必要時請減少L2的距離。

4

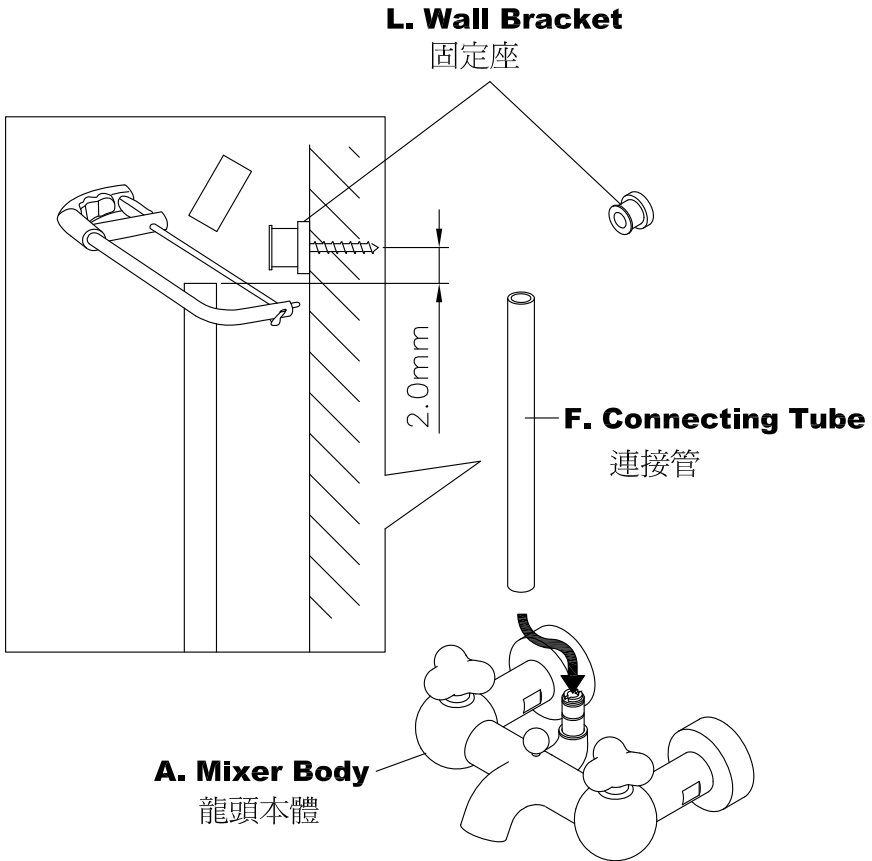

Measure & Cut to reduce the L2 length

* Carefully connect the **Connecting Tube** with **Adapter** of **Mixer Body** and push down the **Connecting Tube** over the O-rings of **Adapter** of **Mixer Body** until it stops at the extreme bottom. Measure before cut off the top-end of **Connecting-Tube** if necessary, ensure the distance between the center of drill hole and the **Connecting-Tube** top-end is 2 mm.

小心地將連接管裝入龍頭本體的接頭上，再將連接管蓋過接頭上的 O-RING 並壓到底。如果連接管需要切斷頂端，在切斷之前先測量並抽出來，確定鑽孔的中心距離連接管頂端為 2mm，進行下一個步驟前，將連接管切斷的端口磨平，不要有銳利的邊緣。

5

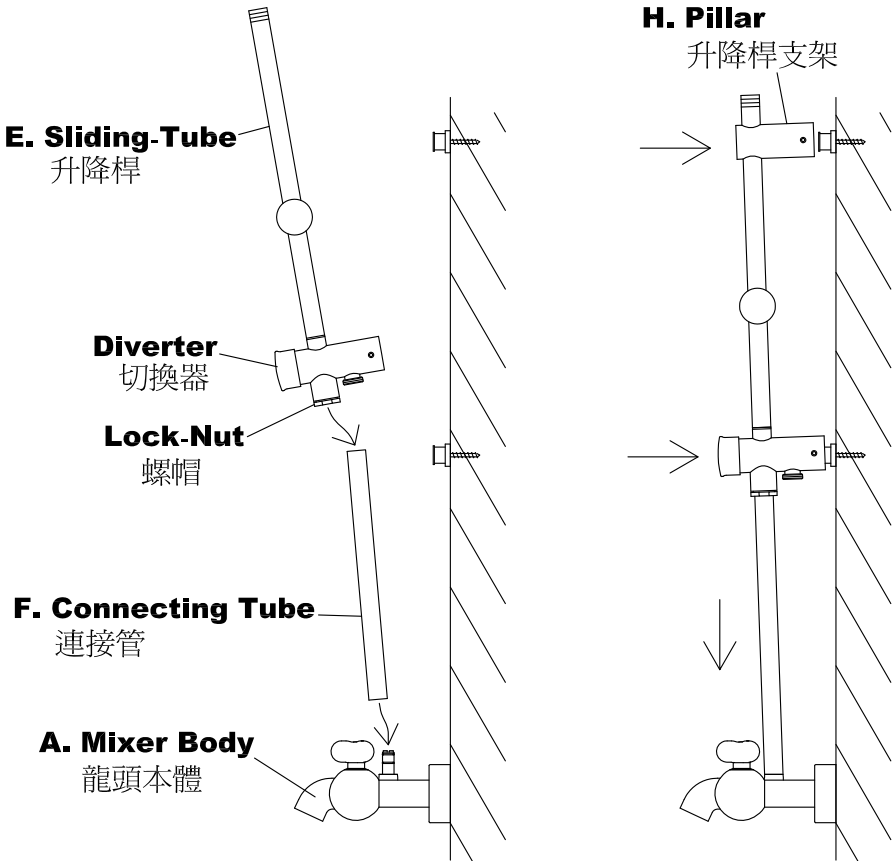

Install Sliding-Tube

* Remove the **Lock-Nut** which fixed under the **Sliding-Tube's** diverter and slide this Lock-Nut over **Connecting-Tube**. Insert **Sliding-Tube** into **Pillar**, then locate both **Pillar** and **Sliding-Tube** over two **Wall Brackets**, meanwhile, insert **Connecting-Tube** top-end into **Sliding-Tube's** diverter bottom-hole and push down the **Sliding-Tube's** diverter until it stop at the extreme deep.

轉鬆升降桿切換器下方的螺帽，插入連接桿。然後將升降桿插入升降桿支架，然後將升降桿支架及升降桿連同連接管裝到牆壁固定座上，同時，將連接管端口插入龍頭本體的接頭並且將升降桿切換器往下壓到停止在盡頭的深度。

6

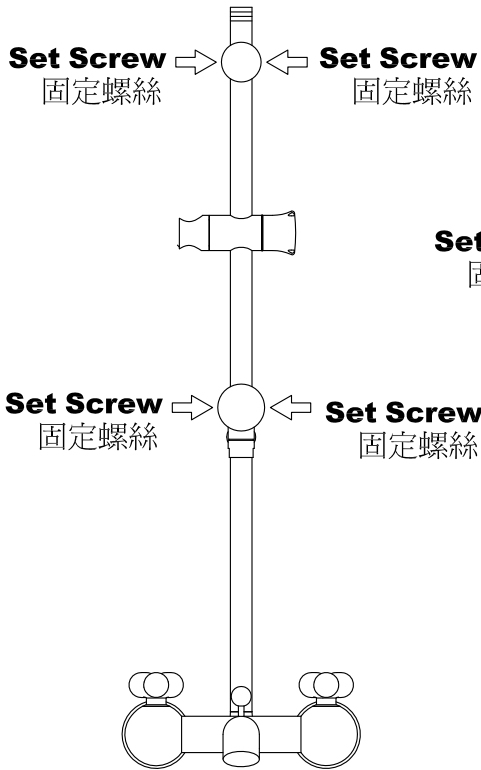

I. Hexagon Key

六角扳手

Set Screw
固定螺絲

Lock-Nut
螺帽

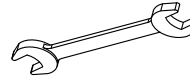

* Tighten the **Set Screws** which on both side of diverter and **Pillar**, then tighten **Lock-Nut** to fix **Connecting-Tube** with **Diverter**.

* Note: Please ensure the **Set Screw** on both side of **Diverter** and **Pillar** has been tightened with **Wall Brackets** when fixing the Shower Set on wall. Do not tighten the **Set Screw** one side only.

將切換器及升降桿支架兩邊的固定螺絲鎖緊，然後鎖緊螺帽固定住連接管及切換器。

注意：固定螺絲共有四處要全部鎖緊，不可只固定單邊。

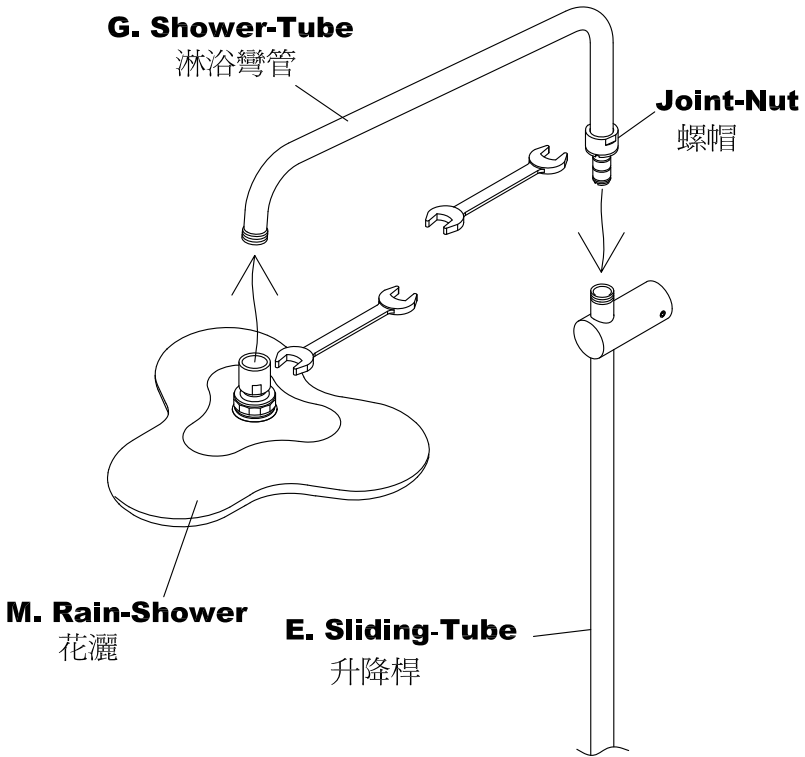

Install Rain Shower

- * Apply pipe compound or sealant tape to the **Shower-Tube** thread end, then tighten the **Shower-Tube** thread end with **Rain-Shower**, then Carefully joint the other O-rings end of **Shower-Tube** into the **Sliding-Tube** and tighten the **Joint-Nut**.

將淋浴彎管末端的牙塗上牙管膠或止洩帶並與花灑鎖緊，然後小心的將淋浴彎管的另一端裝入升降桿並鎖緊淋浴彎管的螺帽。

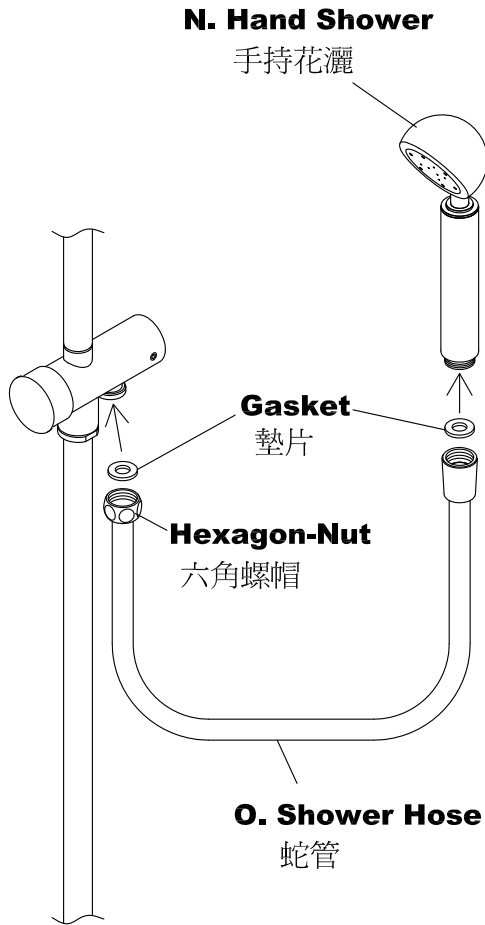

Install Hand Shower

* Connect **Hand Shower & Diverter** with **Shower Hose & Gaskets**.

使用蛇管與墊片連接手持花灑與切換器。

WARRANTY

Sheng Tai Co., Ltd. offer a three-year warranty on all of the Faucets & Bathroom Accessories from date of purchasing. The warranty covers any defect in material and workmanship during normal residential use. The following conditions of defect are charged for maintaining.

- Damage caused by accident, misuse, improper care and cleaning.
- Improper using or installation.
- Defects because of the external factors, such as erodent environment (ex. Seashore or mineral spring.), animal bites or dead body remains in product etc.
- Defect because of sand or impurity stuck in faucet water way.
- Using water not adhered to the regulations of national standard.
- Deficiency caused by freeze.
- Not showing this warranty card.
- Not filling out in the blank of name of customer, date of purchase, cost of purchase, company of installation (retail store) and stamp on warranty card.
- Sheng Tai Co., Ltd. is not responsible for labor charges, installation, or other incidental or consequential costs.

勝泰衛材股份有限公司提供所有的水龍頭及浴室配件，從購買之日起三年保固。保固範圍包括在一般住宅正常使用的期間，發現產品有任何材質和加工上的瑕疵。如瑕疵有下列情形，將收取維修費用。

- 因意外事故、不當操作使用，不當的保養維護和清洗所造成的損害。
- 不當使用或安裝。
- 外在因素造成產品的瑕疵，如易造成侵蝕的環境（如濱海或溫泉地區）、動物嚙咬或屍體存在於產品內造成的損壞。
- 因砂子或雜質卡住水龍頭水路造成的損壞。
- 沒有依循國家標準的規定使用水源造成的損壞。
- 因冰凍造成的水量不足。
- 未出示此保固卡。
- 未在空白處填寫客戶名稱，購買日期，購買成本，安裝公司（零售商店），及保證卡上未蓋章。
- 勝泰衛材股份有限公司不負責工人費用，安裝，或其他附帶或間接產生的費用。

Customer	Name		Tel	
	Address			
Product	Serial No.		Name	
	Warranty	Three year from date of purchase.		
Purchase place	Store		Tel	
	Address			
Purchase Date				
Purchase Price				

JUSTIME
www.justime.com

SHENG TAI BRASSWARE CO., LTD.

No.99 Sec.3 Chang Tsao Rd. Ho Me, Chang Hua, Taiwan

508 台灣彰化縣和美鎮彰草路3段99號

TEL: +886-4-7629971~4

FAX: +886-4-7526980

E-mail: shengtai@ms10.hinet.net

Facebook: www.facebook.com/JUSTIME